



INSTALLATION INSTRUCTIONS FOR:

VUE 2.5 SERIES w/Photocell Option

Revision D



CAUTION:

1. TURN OFF ALL POWER TO POLE BEFORE SERVICING
2. ONLY QUALIFIED PERSONNEL SHOULD PERFORM INSTALLATION OR SERVICING OF FIXTURES

VUE SERIES UNPACKING

Proper lifting locations for removing fixture from box are shown below.

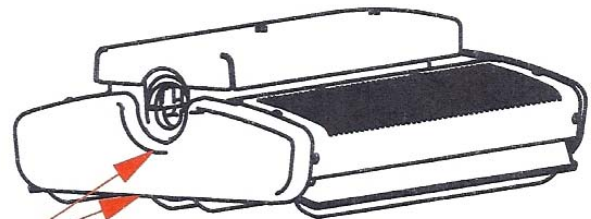

Lift from underneath of the pole insert or below end cap to lift from rear of the fixture.

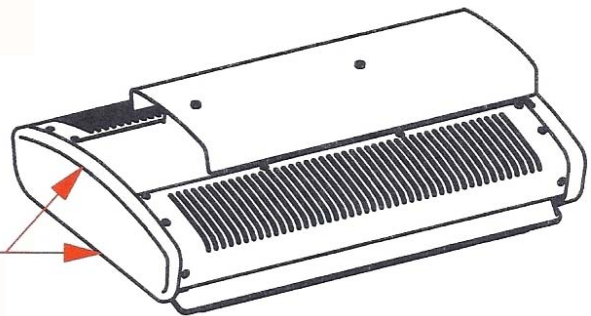

Lift from underneath of the lip edge on end cap or below end cap to lift from front of fixture.

WARNING:

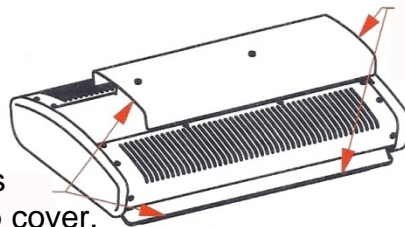

Do not lift fixture from this location! May deform top cover.

Do not lift fixture from this location! May deform top cover.



THIS LED FIXTURE IS A HIGHLY ADVANCED, ENERGY EFFICIENT PRODUCT THAT WILL PROVIDE THE END USER WITH YEARS OF DEPENDABLE SERVICE. IT WILL DO SO ONLY IF INSTALLED PROPERLY IN ACCORDANCE WITH THE NATIONAL ELECTRIC CODE AND OR LOCAL CODE SPECIFICATIONS. FAILURE TO ADHERE TO THESE CODES AND RESTRICTIONS MAY RESULT IN SERIOUS INJURY, DAMAGE TO ADJACENT EQUIPMENT, FIXTURE AND OR POWER SUPPLY AND WILL VOID THE WARRANTY. THE INSTALLATION INSTRUCTIONS DO NOT SUPPORT ALL DETAILS OR VARIATIONS IN EQUIPMENT, NOR DO THEY PROVIDE FOR ALL POSSIBLE CONTINGENCIES RELATED TO THE INSTALLATION, SERVICE OR MOUNTING SITUATION. SHOULD SPECIFIC PROBLEMS OCCUR THAT ARE NOT COVERED BY THE ATTACHED INSTALLATION INSTRUCTIONS, PLEASE CONTACT YOUR SALES REPRESENTATIVE OR DISTRIBUTOR FOR ASSISTANCE. RETAIN THESE INSTALLATION INSTRUCTIONS FOR FUTURE USE. DO NOT MODIFY THIS LIGHTING DEVICE FOR ANY REASON. THESE DEVICES HAVE BEEN DESIGNED FOR MAXIMUM PERFORMANCE AND EASE OF INSTALLATION, ANY MODIFICATIONS WILL VOID THE WARRANTY.



INSTALLATION INSTRUCTIONS FOR:

VUE 2.5 SERIES Photocell Option

Revision D



CAUTION:

1. TURN OFF ALL POWER TO POLE BEFORE SERVICING
2. ONLY QUALIFIED PERSONNEL SHOULD PERFORM INSTALLATION OR SERVICING OF FIXTURES

TOP COVER REMOVAL

- A. Using a flat bade screw driver, remove the top cover of the fixture. Turn fasteners counter clockwise until they release. The top cover is also attached to the main housing via a tether/lanyard.

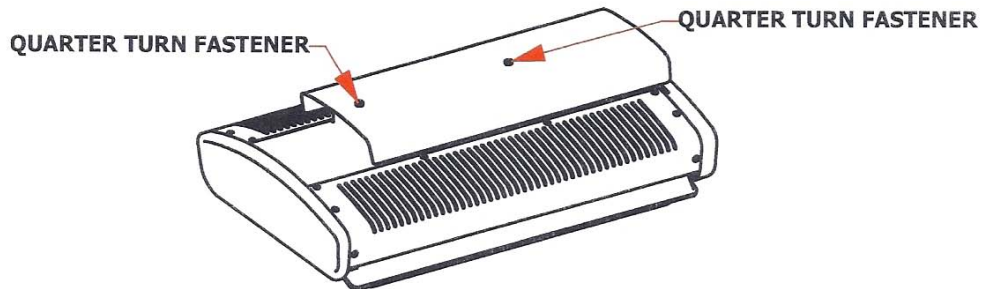

- B. Remove two (2) rear bug guards and foam. Set pieces aside until fixture is mounted onto pole.
- C. Loosen nuts to allow pole clamps to float sufficiently for pole insertion.

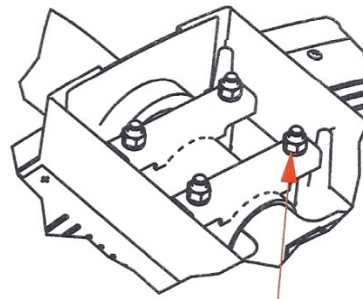
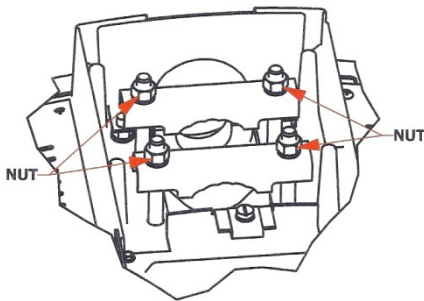

Nut shown tightened
down on clamp around
pole



THIS LED FIXTURE IS A HIGHLY ADVANCED, ENERGY EFFICIENT PRODUCT THAT WILL PROVIDE THE END USER WITH YEARS OF DEPENDABLE SERVICE. IT WILL DO SO ONLY IF INSTALLED PROPERLY IN ACCORDANCE WITH THE NATIONAL ELECTRIC CODE AND OR LOCAL CODE SPECIFICATIONS. FAILURE TO ADHERE TO THESE CODES AND RESTRICTIONS MAY RESULT IN SERIOUS INJURY, DAMAGE TO ADJACENT EQUIPMENT, FIXTURE AND OR POWER SUPPLY AND WILL VOID THE WARRANTY. THE INSTALLATION INSTRUCTIONS DO NOT SUPPORT ALL DETAILS OR VARIATIONS IN EQUIPMENT, NOR DO THEY PROVIDE FOR ALL POSSIBLE CONTINGENCIES RELATED TO THE INSTALLATION, SERVICE OR MOUNTING SITUATION. SHOULD SPECIFIC PROBLEMS OCCUR THAT ARE NOT COVERED BY THE ATTACHED INSTALLATION INSTRUCTIONS, PLEASE CONTACT YOUR SALES REPRESENTATIVE OR DISTRIBUTOR FOR ASSISTANCE. RETAIN THESE INSTALLATION INSTRUCTIONS FOR FUTURE USE. DO NOT MODIFY THIS LIGHTING DEVICE FOR ANY REASON. THESE DEVICES HAVE BEEN DESIGNED FOR MAXIMUM PERFORMANCE AND EASE OF INSTALLATION, ANY MODIFICATIONS WILL VOID THE WARRANTY.



INSTALLATION INSTRUCTIONS FOR:

VUE 2.5 SERIES Photocell Option

Revision D



CAUTION:

1. TURN OFF ALL POWER TO POLE BEFORE SERVICING
2. ONLY QUALIFIED PERSONNEL SHOULD PERFORM INSTALLATION OR SERVICING OF FIXTURES

INSTALLING FIXTURE ONTO POLE

- D. Slide fixture onto the pole and under the mounting clamps until it makes contacts with the stop. Fixture contains a standard rocker between the mounting clamps to allow for adjustability when leveling the fixture.
- a. Tips From Other Installers:
 - i. For personal preference, you can remove the two (2) nuts and clamp closest to the wire terminal and mount light upside down on pole. Slide on far enough to keep light from falling off allowing more clearance to attach the wires, as it is a close fit. Once the wires are attached, replace the clamp and nuts, rotate light right side up and finish installation.
- E. Once fixture is on the pole, adjust as required using the provided bubble level located in the mounting clamp area and tighten the mounting clamp bolts securely to seat fixture in a level position.

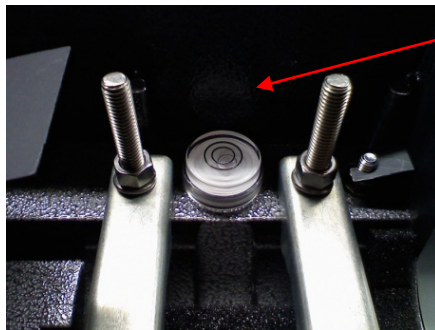

Bubble Level

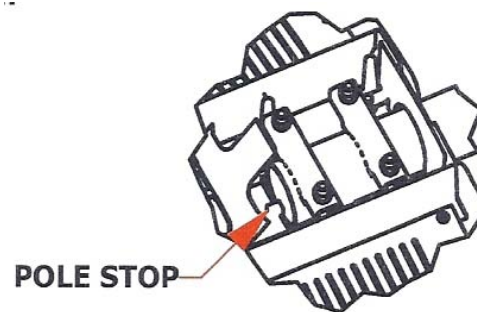

POLE STOP



THIS LED FIXTURE IS A HIGHLY ADVANCED, ENERGY EFFICIENT PRODUCT THAT WILL PROVIDE THE END USER WITH YEARS OF DEPENDABLE SERVICE. IT WILL DO SO ONLY IF INSTALLED PROPERLY IN ACCORDANCE WITH THE NATIONAL ELECTRIC CODE AND OR LOCAL CODE SPECIFICATIONS. FAILURE TO ADHERE TO THESE CODES AND RESTRICTIONS MAY RESULT IN SERIOUS INJURY, DAMAGE TO ADJACENT EQUIPMENT, FIXTURE AND OR POWER SUPPLY AND WILL VOID THE WARRANTY. THE INSTALLATION INSTRUCTIONS DO NOT SUPPORT ALL DETAILS OR VARIATIONS IN EQUIPMENT, NOR DO THEY PROVIDE FOR ALL POSSIBLE CONTINGENCIES RELATED TO THE INSTALLATION, SERVICE OR MOUNTING SITUATION. SHOULD SPECIFIC PROBLEMS OCCUR THAT ARE NOT COVERED BY THE ATTACHED INSTALLATION INSTRUCTIONS, PLEASE CONTACT YOUR SALES REPRESENTATIVE OR DISTRIBUTOR FOR ASSISTANCE. RETAIN THESE INSTALLATION INSTRUCTIONS FOR FUTURE USE. DO NOT MODIFY THIS LIGHTING DEVICE FOR ANY REASON. THESE DEVICES HAVE BEEN DESIGNED FOR MAXIMUM PERFORMANCE AND EASE OF INSTALLATION, ANY MODIFICATIONS WILL VOID THE WARRANTY.



INSTALLATION INSTRUCTIONS FOR:

VUE 2.5 SERIES Photocell Option

Revision D



CAUTION:

1. TURN OFF ALL POWER TO POLE BEFORE SERVICING
2. ONLY QUALIFIED PERSONNEL SHOULD PERFORM INSTALLATION OR SERVICING OF FIXTURES

WIRING THE FIXTURE

- F. Located forward of the pole stop is a terminal block for connecting your wiring to the fixture. The terminal block will specify the wiring connections (ground, line, line). Verify the fixture voltage matches the line voltage. IF they do not match, **STOP** and contact customer service.
- G. Complete electrical connections, fold terminal block cover and insert flap into the end of the pole as shown.

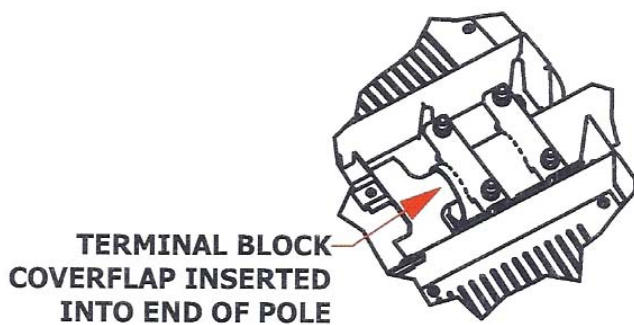
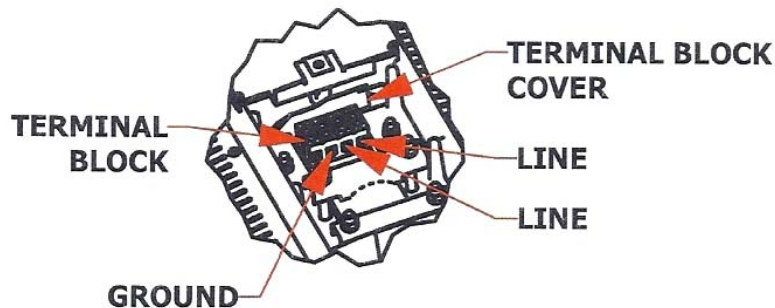

THIS LED FIXTURE IS A HIGHLY ADVANCED, ENERGY EFFICIENT PRODUCT THAT WILL PROVIDE THE END USER WITH YEARS OF DEPENDABLE SERVICE. IT WILL DO SO ONLY IF INSTALLED PROPERLY IN ACCORDANCE WITH THE NATIONAL ELECTRIC CODE AND OR LOCAL CODE SPECIFICATIONS. FAILURE TO ADHERE TO THESE CODES AND RESTRICTIONS MAY RESULT IN SERIOUS INJURY, DAMAGE TO ADJACENT EQUIPMENT, FIXTURE AND OR POWER SUPPLY AND WILL VOID THE WARRANTY. THE INSTALLATION INSTRUCTIONS DO NOT SUPPORT ALL DETAILS OR VARIATIONS IN EQUIPMENT, NOR DO THEY PROVIDE FOR ALL POSSIBLE CONTINGENCIES RELATED TO THE INSTALLATION, SERVICE OR MOUNTING SITUATION. SHOULD SPECIFIC PROBLEMS OCCUR THAT ARE NOT COVERED BY THE ATTACHED INSTALLATION INSTRUCTIONS, PLEASE CONTACT YOUR SALES REPRESENTATIVE OR DISTRIBUTOR FOR ASSISTANCE. RETAIN THESE INSTALLATION INSTRUCTIONS FOR FUTURE USE. DO NOT MODIFY THIS LIGHTING DEVICE FOR ANY REASON. THESE DEVICES HAVE BEEN DESIGNED FOR MAXIMUM PERFORMANCE AND EASE OF INSTALLATION, ANY MODIFICATIONS WILL VOID THE WARRANTY.



INSTALLATION INSTRUCTIONS FOR:

VUE 2.5 SERIES Photocell Option

Revision D



CAUTION:

1. TURN OFF ALL POWER TO POLE BEFORE SERVICING
2. ONLY QUALIFIED PERSONNEL SHOULD PERFORM INSTALLATION OR SERVICING OF FIXTURES

BUG GUARD INSERTION

A. The bug guard used is determined by the pole size being used. Ensure that the guard is placed on the threaded bolts as shown below by snapping the adjustable finger over bolt head. NOTE: that the bend of the lower tabs are bent in this shape, in relation to the natural curvature of the guard. This will ensure good seating against the fixture when it is installed.

REAR BUG GUARD

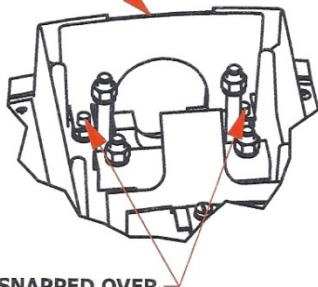

BUG GUARD IS SNAPPED OVER THESE BOLTS AND REST AGAINST REAR OF FIXTURE

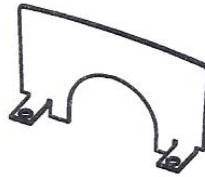

LARGE REAR BUG GUARD

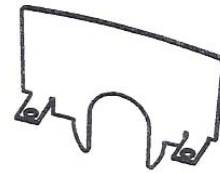

SMALL REAR BUG GUARD

Back Wall of Fixture

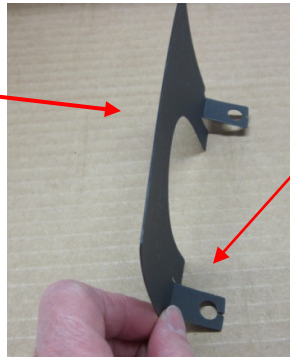

To ensure proper tension, insert bug guard as shown



THIS LED FIXTURE IS A HIGHLY ADVANCED, ENERGY EFFICIENT PRODUCT THAT WILL PROVIDE THE END USER WITH YEARS OF DEPENDABLE SERVICE. IT WILL DO SO ONLY IF INSTALLED PROPERLY IN ACCORDANCE WITH THE NATIONAL ELECTRIC CODE AND OR LOCAL CODE SPECIFICATIONS. FAILURE TO ADHERE TO THESE CODES AND RESTRICTIONS MAY RESULT IN SERIOUS INJURY, DAMAGE TO ADJACENT EQUIPMENT, FIXTURE AND OR POWER SUPPLY AND WILL VOID THE WARRANTY. THE INSTALLATION INSTRUCTIONS DO NOT SUPPORT ALL DETAILS OR VARIATIONS IN EQUIPMENT, NOR DO THEY PROVIDE FOR ALL POSSIBLE CONTINGENCIES RELATED TO THE INSTALLATION, SERVICE OR MOUNTING SITUATION. SHOULD SPECIFIC PROBLEMS OCCUR THAT ARE NOT COVERED BY THE ATTACHED INSTALLATION INSTRUCTIONS, PLEASE CONTACT YOUR SALES REPRESENTATIVE OR DISTRIBUTOR FOR ASSISTANCE. RETAIN THESE INSTALLATION INSTRUCTIONS FOR FUTURE USE. DO NOT MODIFY THIS LIGHTING DEVICE FOR ANY REASON. THESE DEVICES HAVE BEEN DESIGNED FOR MAXIMUM PERFORMANCE AND EASE OF INSTALLATION, ANY MODIFICATIONS WILL VOID THE WARRANTY.



INSTALLATION INSTRUCTIONS FOR:

VUE 2.5 SERIES Photocell Option

Revision D



CAUTION:

1. TURN OFF ALL POWER TO POLE BEFORE SERVICING
2. ONLY QUALIFIED PERSONNEL SHOULD PERFORM INSTALLATION OR SERVICING OF FIXTURES

BUG GUARD INSERTION (continued)

- I. After installing the bug guard properly on the rear bolts, clean the visible pole area just in front of the bug guard. Apply the foam in this area to ensure a good adhesion to the pole as shown.

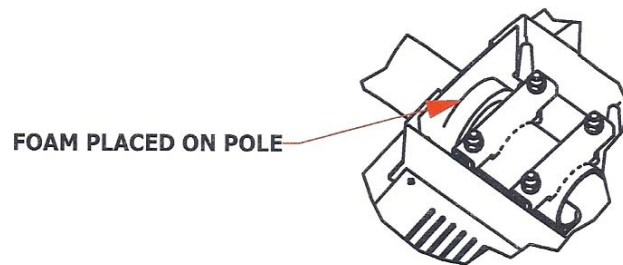

- J. Reinstall the top cover back onto the fixture. Align the quarter turn fasteners with their receptacle and insert fasteners into their clips.
- K. Use a flat blade screw driver to turn the fasteners in a clockwise direction until they snap into place and the top cover is secured.

Installation is now complete and you may now restore power to the pole and light up the fixture.



THIS LED FIXTURE IS A HIGHLY ADVANCED, ENERGY EFFICIENT PRODUCT THAT WILL PROVIDE THE END USER WITH YEARS OF DEPENDABLE SERVICE. IT WILL DO SO ONLY IF INSTALLED PROPERLY IN ACCORDANCE WITH THE NATIONAL ELECTRIC CODE AND OR LOCAL CODE SPECIFICATIONS. FAILURE TO ADHERE TO THESE CODES AND RESTRICTIONS MAY RESULT IN SERIOUS INJURY, DAMAGE TO ADJACENT EQUIPMENT, FIXTURE AND OR POWER SUPPLY AND WILL VOID THE WARRANTY. THE INSTALLATION INSTRUCTIONS DO NOT SUPPORT ALL DETAILS OR VARIATIONS IN EQUIPMENT, NOR DO THEY PROVIDE FOR ALL POSSIBLE CONTINGENCIES RELATED TO THE INSTALLATION, SERVICE OR MOUNTING SITUATION. SHOULD SPECIFIC PROBLEMS OCCUR THAT ARE NOT COVERED BY THE ATTACHED INSTALLATION INSTRUCTIONS, PLEASE CONTACT YOUR SALES REPRESENTATIVE OR DISTRIBUTOR FOR ASSISTANCE. RETAIN THESE INSTALLATION INSTRUCTIONS FOR FUTURE USE. DO NOT MODIFY THIS LIGHTING DEVICE FOR ANY REASON. THESE DEVICES HAVE BEEN DESIGNED FOR MAXIMUM PERFORMANCE AND EASE OF INSTALLATION, ANY MODIFICATIONS WILL VOID THE WARRANTY.



INSTALLATION INSTRUCTIONS FOR:

VUE 2.5 SERIES Photocell Option

Revision D



CAUTION:

1. TURN OFF ALL POWER TO POLE BEFORE SERVICING
2. ONLY QUALIFIED PERSONNEL SHOULD PERFORM INSTALLATION OR SERVICING OF FIXTURES

PHOTOCELL INSTALLATION

- L. The receiving socket is tightened for shipping. After installing the fixture, loosen the two (2) screws and turn the socket so that it faces towards north, then tighten screws to maintain position.
- M. Insert a twist lock photocell with gasket into the socket. Twist clockwise into position.

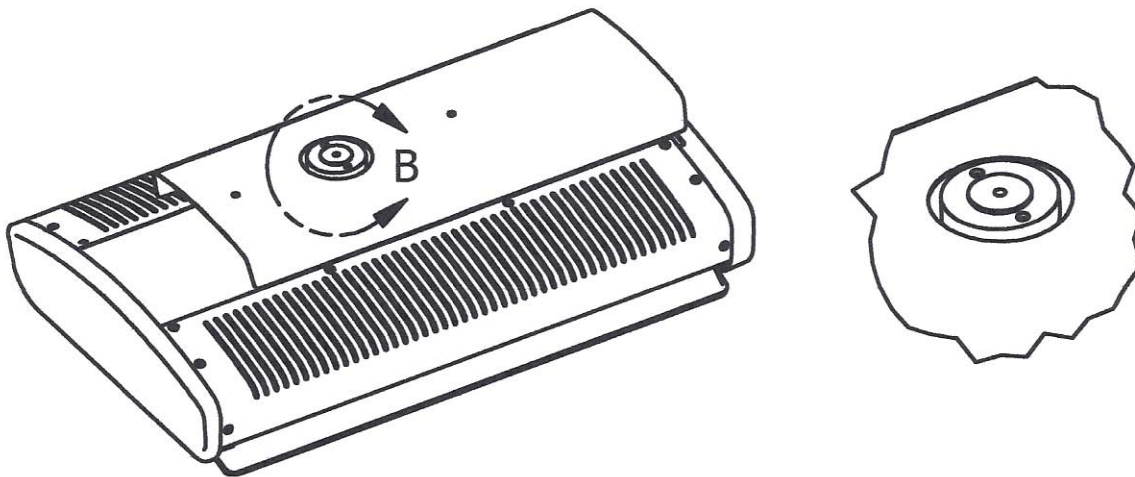

Installation is now complete and you may now restore power to the pole and light up the fixture.



THIS LED FIXTURE IS A HIGHLY ADVANCED, ENERGY EFFICIENT PRODUCT THAT WILL PROVIDE THE END USER WITH YEARS OF DEPENDABLE SERVICE. IT WILL DO SO ONLY IF INSTALLED PROPERLY IN ACCORDANCE WITH THE NATIONAL ELECTRIC CODE AND OR LOCAL CODE SPECIFICATIONS. FAILURE TO ADHERE TO THESE CODES AND RESTRICTIONS MAY RESULT IN SERIOUS INJURY, DAMAGE TO ADJACENT EQUIPMENT, FIXTURE AND OR POWER SUPPLY AND WILL VOID THE WARRANTY. THE INSTALLATION INSTRUCTIONS DO NOT SUPPORT ALL DETAILS OR VARIATIONS IN EQUIPMENT, NOR DO THEY PROVIDE FOR ALL POSSIBLE CONTINGENCIES RELATED TO THE INSTALLATION, SERVICE OR MOUNTING SITUATION. SHOULD SPECIFIC PROBLEMS OCCUR THAT ARE NOT COVERED BY THE ATTACHED INSTALLATION INSTRUCTIONS, PLEASE CONTACT YOUR SALES REPRESENTATIVE OR DISTRIBUTOR FOR ASSISTANCE. RETAIN THESE INSTALLATION INSTRUCTIONS FOR FUTURE USE. DO NOT MODIFY THIS LIGHTING DEVICE FOR ANY REASON. THESE DEVICES HAVE BEEN DESIGNED FOR MAXIMUM PERFORMANCE AND EASE OF INSTALLATION, ANY MODIFICATIONS WILL VOID THE WARRANTY.